

Fail-Safe actuator used in typical Fire and Smoke damper applications

- Torque motor 18 in-lb [2 Nm]
- Nominal voltage AC 230 V
- Control On/Off
- @ 250°F [121°C] for 30 min
- 75 s, <25 s Motor/Fail-safe



5-year warranty

Technical data

Electrical data	Nominal voltage	AC 230 V
	Nominal voltage frequency	50/60 Hz
	Nominal voltage range	AC 207...253 V
	Power consumption in operation	2.5 W
	Power consumption in rest position	4.5 VA
	Transformer sizing	5 VA
	Connection supply	cable 3 ft. [1 m], 2x 18 AWG appliance cable with 1/2" NPT conduit connector
	Overload Protection	electronic throughout 0...95° rotation
	Electrical Protection	actuators are double insulated
Functional data	Torque motor	18 in-lb [2 Nm] @ 250°F [121°C] for 30 min
	Direction of motion motor	selectable by ccw/cw mounting
	Direction of motion fail-safe	reversible with cw/ccw mounting
	Angle of rotation	95°
	Running Time (Motor)	75 s / 90°
	Running time motor note	@ 250°F [121°C]
	Running time fail-safe	<25 s @ 32...122°F [0...50°C]
	Noise level, motor	45 dB(A)
	Noise level, fail-safe	62 dB(A)
	Position indication	Mechanical
Safety data	Degree of protection IEC/EN	IP42
	Degree of protection NEMA/UL	NEMA 2
	Enclosure	UL Enclosure Type 2
	Agency Listing	cULus acc. to UL60730-1A/-2-14, CAN/CSA E60730-1:02
	Quality Standard	ISO 9001
	UL 2043 Compliant	Suitable for use in air plenums per Section 300.22(C) of the NEC and Section 602 of the IMC
	Ambient humidity	Max. 95% RH, non-condensing
	Ambient temperature	32...122°F [0...50°C]
	Storage temperature	-40...176°F [-40...80°C]
	Servicing	maintenance-free
Weight	Weight	1.6 lb [0.71 kg]
Materials	Housing material	UL94-5VA

Technical data

- Footnotes**
- Part no. Clamp side spring-return
 - FSTF120 US CW
 - FSTF120.1 US CW (bulk pack)
 - FSTF120.1 CCW CCW (bulk pack)
 - FSTF120-S US CW CW
 - FSTF120-S.1 US CW (bulk pack)
 - FSTF120-S.1 CCW CCW (bulk pack)
 - FSTF24-S.1 US CW (bulk pack)

Safety notes



- Screw a conduit fitting into the actuator’s bushing. Jacket the actuator’s input and output wiring with suitable flexible conduit. Properly terminate the conduit in a suitable junction box.
- Retrofit Safety Note
- Use of the FSTF for replacement of other makes of actuators is limited in damper area. The FSLF is preferred for direct coupled applications. The FSTF may be applied for linkage applications on dampers 1.5 sq.ft. and smaller at velocities under 2000 fpm.





Product features

- Application** The FS series of spring-return actuators are designed for the operation of UL555 and UL555S listed fire/smoke dampers in ventilation and air-conditioning systems.
- Operation** The actuator is mounted in its fail safe position with the damper blade(s) typically closed. Upon applying power, the actuator drives the damper to the open position. The internal spring is tensioned at the same time. If the power supply is interrupted, the spring moves the damper back to its fail-safe position.
- Typical specification** All smoke and combination fire and smoke dampers shall be provided with Belimo FSTF, FSLF, FSNF, or FSAF series actuators. All substitutions must be approved before submission of bid. Damper and actuator shall have UL555S Listing for 250°F and/or 350°F. Actuator shall have been tested to UL2043 per requirements of IMC 602.2 and NEC 300.22 (c). Where position indication is required -S models with auxiliary switches shall be provided.

Accessories

Electrical accessories	Description	Type
	Thermoelectric tripping device, Duct inside temperature 165°F	BAE165 US
Mechanical accessories	Description	Type
	Position indicator for TFB(X)	IND-TF
	Ball joint suitable for damper crank arm KH8	KG8
	TFB(X) crankarm with 5/16" slot.	KH-TF US
	TFB(X) crankarm with 1/4" slot.	KH-TF-1 US
	Anti-rotation bracket TF/NKQ/AM/NM/LM.	TF-P
	Wrench 0.32 in and 0.39 in [8 mm and 10 mm]	TOOL-06
	Angle of rotation limiter, with end stop	ZDB-TF
	TFB(X) crankarm adaptor kit (T bracket included).	ZG-TF2
	Mounting kit for TFB(X)	ZG-TF3
	TFB(X) crankarm adaptor kit (includes ZG-113).	ZG-TF112
	Weather shield 13x8x6" [330x203x152 mm] (LxWxH)	ZS-100
	Weather shield 406x213x102 mm [16x8-3/8x4"] (LxWxH)	ZS-150

Electrical installation

-  Provide overload protection and disconnect as required.
-  Actuators may be powered in parallel. Power consumption must be observed.
-  Ground present on some models.
-  Meets cULus requirements without the need of an electrical ground connection.

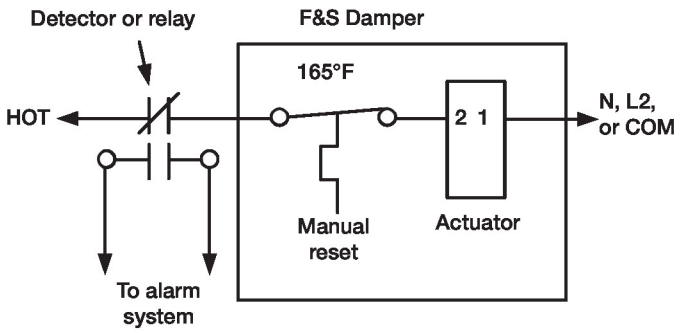

Typical containment damper control wiring

Wiring diagrams

AC 230 V

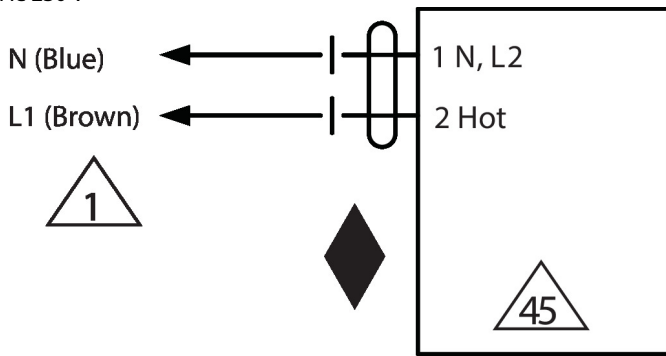

Typical smoke or fusible link damper wiring

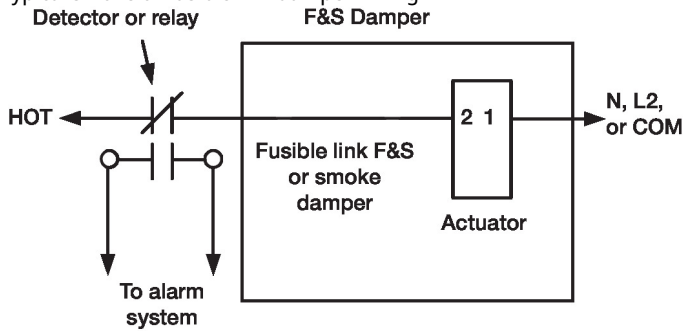

Parallel Actuator Wiring

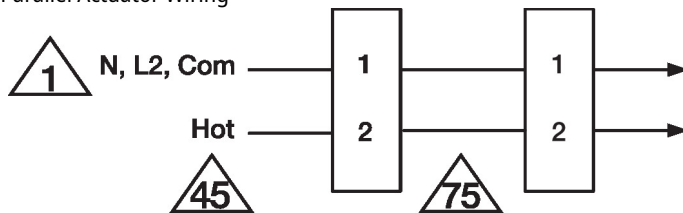

Dimensions

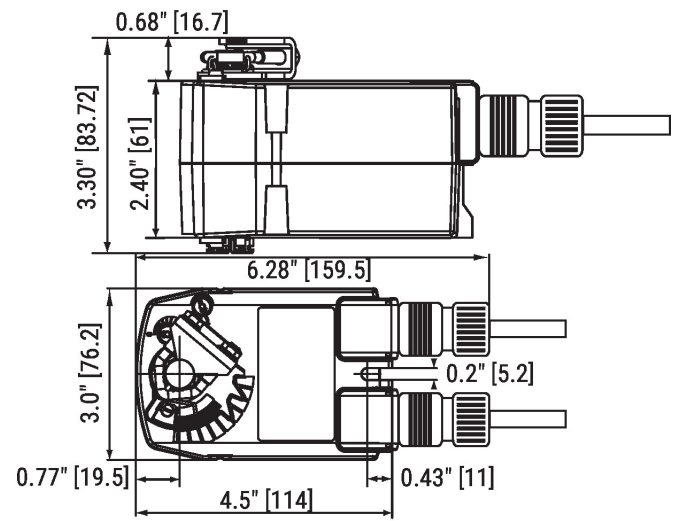

Standard:

∅ 1/4" to 1/2"

□ 1/4" to 5/16"